

PROPRIETARY NOTICE
 This Document and the data disclosed herein shall not be reproduced, copied, used or disclosed in whole or in part to anyone without the written permission of JE PISTONS.

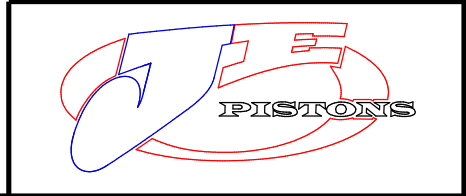
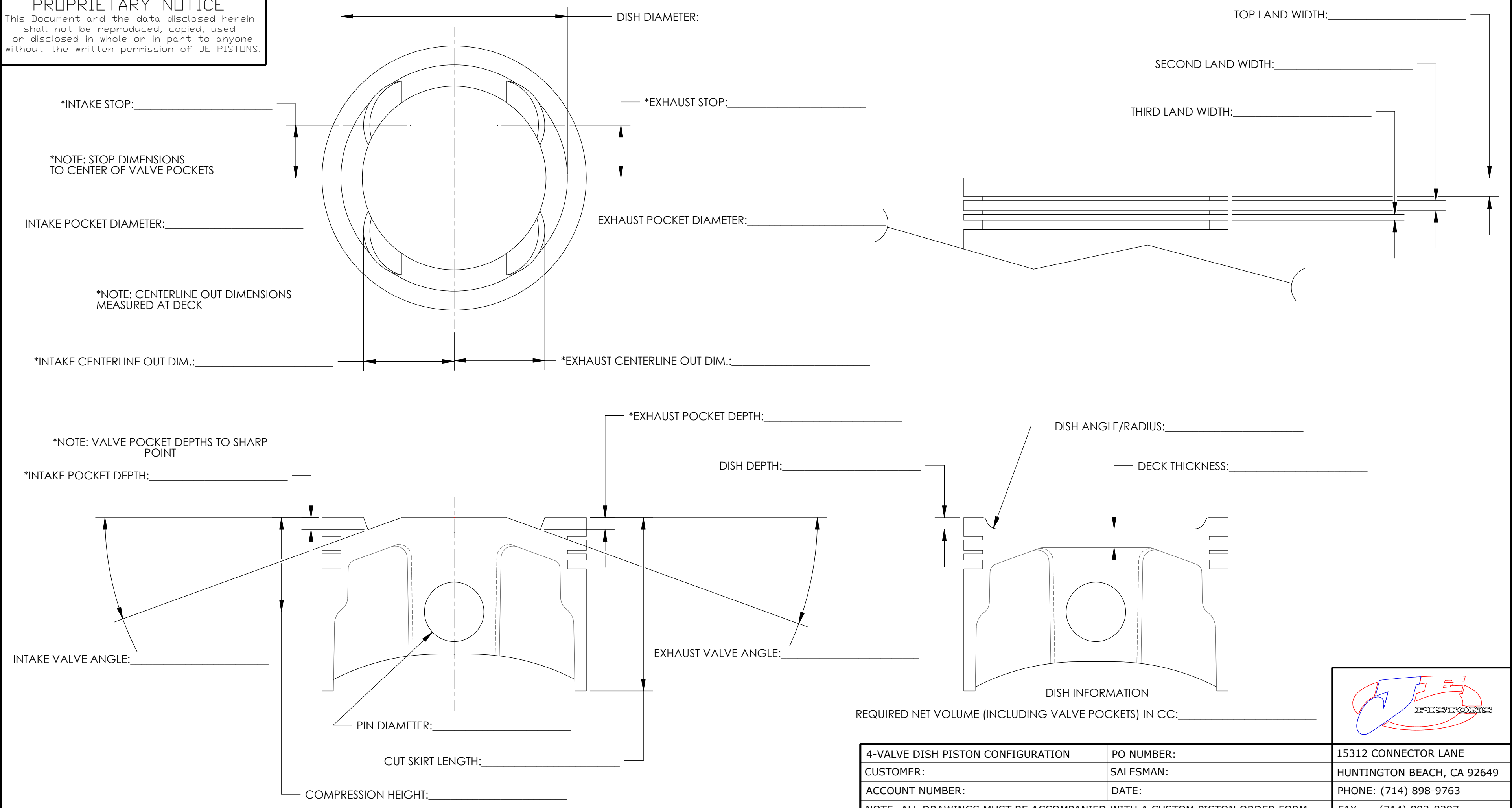

4-VALVE DISH PISTON CONFIGURATION	PO NUMBER:	15312 CONNECTOR LANE
CUSTOMER:	SALESMAN:	HUNTINGTON BEACH, CA 92649
ACCOUNT NUMBER:	DATE:	PHONE: (714) 898-9763
NOTE: ALL DRAWINGS MUST BE ACCOMPANIED WITH A CUSTOM PISTON ORDER FORM		FAX: (714) 893-8297